

ALTLIKLAR / SHIMS / UNTERLAGE

ÜRÜN RESMİ/PICTURE BILD	ÜRÜN KODU/CODE BEZEICHNUNG	ÜRÜN DETAYI / PRODUCT DETAIL PRODUKTBESCHREIBUNG	
	AATN-2-0001	S-SİSTEM için / For S-SYSTEM / FÜR S-SYSTEM	
	AATN-2-0002	T-M SİSTEM için / For T-M SYSTEM / FÜR T-M-SYSTEM	
	AATN-3-0025	P-SİSTEM için / For P-SYSTEM / FÜR P-SYSTEM	
	AATN-3-0015	T-M-P SİSTEM için / For T-M SYSTEM / FÜR T-M-P-SYSTEM	
	AATN-2-0020	DİŞ VİDA 16 ALTLIK / For THREADING 16 SHIM / GEWINDE 16 UNTERLAGE	
	AATN-2-0004	DİŞ VİDA 22 ALTLIK / For THREADING 22 SHIM / GEWINDE 22 UNTERLAGE	
	ATS-16E	DİŞ VİDA 16, DİŞ ÇAP SAĞ - DELİK İÇİ SOL ALTLIK / For THREADING SYSTEM 16 SHIM, EXTERNAL RIGHT-INTERNAL LEFT / FÜR 16 ER-GEWINDEPLATTE, EXTERN RECHTS - INTERN LINKS	
	ATS-16I	DİŞ VİDA 16, DİŞ ÇAP SOL - DELİK İÇİ SAĞ ALTLIK / For THREADING SYSTEM 16 SHIM, EXTERNAL LEFT-INTERNAL RIGHT / FÜR 16 ER-GEWINDEPLATTE, EXTERN LINKS - INTERN RECHTS	
	ATS-22E	DİŞ VİDA 22, DİŞ ÇAP SAĞ - DELİK İÇİ SOL ALTLIK / For THREADING SYSTEM 22 SHIM, EXTERNAL RIGHT-INTERNAL LEFT / FÜR 22 ER-GEWINDEPLATTE, EXTERN RECHTS - INTERN LINKS	
	ATS-22I	DİŞ VİDA 22, DİŞ ÇAP SOL - DELİK İÇİ SAĞ ALTLIK / For THREADING SYSTEM 22 SHIM, EXTERNAL LEFT-INTERNAL RIGHT / FÜR 22 ER-GEWINDEPLATTE, EXTERN LINKS - INTERN RECHTS	
	ATS-27E	DİŞ VİDA 27, DİŞ ÇAP SAĞ - DELİK İÇİ SOL ALTLIK / For THREADING SYSTEM 27 SHIM, EXTERNAL RIGHT-INTERNAL LEFT / FÜR 27 ER-GEWINDEPLATTE, EXTERN RECHTS - INTERN LINKS	
	ATS-27I	DİŞ VİDA 27, DİŞ ÇAP SOL - DELİK İÇİ SAĞ ALTLIK / For THREADING SYSTEM 27 SHIM, EXTERNAL LEFT-INTERNAL RIGHT / FÜR 27 ER-GEWINDEPLATTE, EXTERN LINKS - INTERN RECHTS	
	AACN-2-0001	S-SİSTEM için / For S-SYSTEM / FÜR S-SYSTEM	
	AACN-2-0002	T-SİSTEM için / For T-SYSTEM / FÜR T-T-SYSTEM	
	AACN-2-0003	P-SİSTEM için / For P-SYSTEM / FÜR P-SYSTEM	
	AACN-3-0001	S-SİSTEM için / For S-SYSTEM / FÜR S-SYSTEM	
	AACN-3-0002	T-M-P SİSTEM için / For T-M-P SYSTEM / FÜR T-M-P-SYSTEM	
	AACN-3-0003	C-SİSTEM için / For C-SYSTEM / FÜR C-SYSTEM	
	AACN-3-0002	T-P SİSTEM için / For T-P SYSTEM / FÜR T-P-SYSTEM	
	AACN-3-0003	T-P SİSTEM için / For T-P SYSTEM / FÜR T-P-SYSTEM	
	AAWN-2-0003	T-M-P SİSTEM için / For T-M-P SYSTEM / FÜR T-M-P-SYSTEM	
	AAWN-3-0001	T-M-P SİSTEM için / For T-M-P SYSTEM / FÜR T-M-P-SYSTEM	
	AAWN-SW317	T-M-P SİSTEM için / For T-M-P SYSTEM / FÜR T-M-P-SYSTEM	
	AKS-16L	C-SİSTEM için / For C-SYSTEM / FÜR C-SYSTEM	
	AKS-16R	C-SİSTEM için / For C-SYSTEM / FÜR C-SYSTEM	
	AASD-3-0001	S-SİSTEM FREZELEME için / For S-SYSTEM MILLING / S-SYSTEM FÜR FRÄSER	
	AASE-3-0001	S-SİSTEM FREZELEME için / For S-SYSTEM MILLING / S-SYSTEM FÜR FRÄSER	
	AASN-2-0001	S-SİSTEM için / For S-SYSTEM / FÜR S-SYSTEM	
	AASN-2-0002	P-SİSTEM için / For P-SYSTEM / FÜR P-SYSTEM	
	AASN-2-0004	S-SİSTEM için / For S-SYSTEM / FÜR S-SYSTEM	
	AASN-3-0004	T-P SİSTEM için / For T-P SYSTEM / FÜR T-P-SYSTEM	
	AASN-3-0004	C-SİSTEM için / For C-SYSTEM / FÜR C-SYSTEM	
	AASN-3-0023	T-P SİSTEM için / For T-P SYSTEM / FÜR T-P-SYSTEM	
	AASN-3-0005	T-P SİSTEM için / For T-P SYSTEM / FÜR T-P-SYSTEM	
	AASN-3-0020	T-P SİSTEM için / For T-P SYSTEM / FÜR T-P-SYSTEM	
	AASN-20020	PSDNN KARTUŞ için / For PSDNN CARTRIDGE / FÜR PSDNN-KURZDREHHALTER	
		AADN-2-0001	S-SİSTEM için / For S-SYSTEM / FÜR S-SYSTEM
		AADN-SD317	T-SİSTEM için / For T-SYSTEM / FÜR T-SYSTEM
		AADN-3-0001	P-SİSTEM için / For P-SYSTEM / FÜR P-SYSTEM
AADN-3-0001		T-M-P SİSTEM için / For T-M-P SYSTEM / FÜR T-M-P-SYSTEM	
	AADN-2-0003	C-SİSTEM için / For C-SYSTEM / FÜR C-SYSTEM	
	AADN-2-0003	T-SİSTEM için / For T-SYSTEM / FÜR T-SYSTEM	
	AAVN-2-0002	S-SİSTEM için / For S-SYSTEM / FÜR S-SYSTEM	
	AAVN-2-0002	T-SİSTEM için / For T-SYSTEM / FÜR T-SYSTEM	
	AARC-3-0001	C-SİSTEM için / For C-SYSTEM / FÜR C-SYSTEM	
	AARC-3-0002	C-SİSTEM için / For C-SYSTEM / FÜR C-SYSTEM	
	AARC-3-0003	C-SİSTEM için / For C-SYSTEM / FÜR C-SYSTEM	



BASKI PABUÇLARI / CLAMPS / SPANNSPRATZE

ÜRÜN RESMİ/PICTURE BILD	ÜRÜN KODU/CODE BEZEICHNUNG	ÜRÜN DETAYI / PRODUCT DETAIL PRODUKTBESCHREIBUNG
	ATK-01	T-SİSTEM için / For T-SYSTEM / FÜR T-SYSTEM DNMG 11, WNMG 06, TNMG 16, CNMG 09 BASKI PABUCU / CLAMP / PRATZE
	ATK-02	T-SİSTEM için / For T-SYSTEM / FÜR T-SYSTEM CNMG 12, WNMG 08, TNMG 22, DNMG 15, SNMG 12 BASKI PABUCU / CLAMP / PRATZE
	ATK-03	T-SİSTEM için / For T-SYSTEM / FÜR T-SYSTEM VNMG 16 BASKI PABUCU / CLAMP / PRATZE
	ATK-04	T-SİSTEM için / For T-SYSTEM / FÜR T-SYSTEM CNMG 16, SNMG 15 BASKI PABUCU / CLAMP / PRATZE
	AMK-01	M-SİSTEM için / For M-SYSTEM / FÜR M-SYSTEM WNMG 06 BASKI PABUCU / CLAMP / PRATZE
	AMK-02	M-SİSTEM için / For M-SYSTEM / FÜR M-SYSTEM DELİK İÇİ / INTERN / INNEN Ø20 TNMG 16, Ø25 MT-NR/L 16 BASKI PABUCU / CLAMP / PRATZE
	AMK-03	M-SİSTEM için / For M-SYSTEM / FÜR M-SYSTEM DNMG 11, CNMG 12 BASKI PABUCU / CLAMP / PRATZE
	AMK-04	M-SİSTEM için / For M-SYSTEM / FÜR M-SYSTEM DNMG 15, TNMG 16-22 BASKI PABUCU / CLAMP / PRATZE
	AMK-05	M-SİSTEM için / For M-SYSTEM / FÜR M-SYSTEM WNMG 08 BASKI PABUCU / CLAMP / PRATZE
	AMK-07	M-SİSTEM için / For M-SYSTEM / FÜR M-SYSTEM S20R MCLNR/L BASKI PABUCU / CLAMP / PRATZE
	ACK-01-R	C-SİSTEM için / For C-SYSTEM / FÜR C-SYSTEM KNUX-R BASKI PABUCU / CLAMP / PRATZE
	ACK-02-L	C-SİSTEM için / For C-SYSTEM / FÜR C-SYSTEM KNUX-L BASKI PABUCU / CLAMP / PRATZE
	ACK-03	C-SİSTEM için / For C-SYSTEM / FÜR C-SYSTEM 154.91 DIŞ ÇAP ve DELİK İÇİ/EXTERNAL and INTERNAL/ AUßEN-DREHHALTER Ø25-Ø32 / PABUCU / CLAMP / PRATZE
	ACK-04	P-C-SİSTEM için / For P-C-SYSTEM / FÜR P-C-SYSTEM CTFPR KARTUŞ BASKI PABUCU / CARTRIDGE CLAMP / PRATZE FÜR KASSETTE
	ACK-05	P-C-SİSTEM için / For P-C-SYSTEM / FÜR P-C-SYSTEM FREZELEME ve DIŞ VIDA AÇMA TAKIMLARINA GÖRE İLAVE BASKI PABUCU ADDITIONAL LITTLE CLAMP for MILLING and THREADING CLAMP KLEINE ZUSATZKLEMME FÜR FRÄSER UND GEWINDEWERKZEUGE
	ACK-06	C-SİSTEM için / For C-SYSTEM / FÜR C-SYSTEM 154.91 DELİK İÇİ / INTERNAL / INNEN Ø16-Ø20 BASKI PABUCU / CLAMP / PRATZE
	ACK-07	C-SİSTEM için / For C-SYSTEM / FÜR C-SYSTEM SERAMİK CNGN, SNGN, DNGN YEDEK TAKIMI SPARE PART SET of CERAMIC CNGN, SNGN, DNGN ERSATZTEILSATZ FÜR KERAMIK CNGN, SNGN, DNGN
	ACK-08	C-SİSTEM için / For C-SYSTEM / FÜR C-SYSTEM SERAMİK TNGN, YEDEK TAKIMI SPARE PART SET of CERAMIC TNGN ERSATZTEILSATZ FÜR KERAMIK TNGN
	ACK-09	P-SİSTEM için / For P-SYSTEM / FÜR P-SYSTEM CNMG 16-19, SNMG 15-19 İLAVE BÜYÜK BASKI PABUCU ADDITIONAL BIG CLAMP / ZUSÄTZLICHE GROSSE KLEMME
	ACK-10	C-SİSTEM FREZELEME için / For C-SYSTEM MILLING C-SYSTEM FÜR FRÄSER SPKN 12, Ø50-Ø63 TPKN 16 BASKI PABUCU / CLAMP / PRATZE (M8x8)
	ACK-11	C-SİSTEM FREZELEME için / For C-SYSTEM MILLING C-SYSTEM FÜR FRÄSER Ø80-Ø100 TPKN 16-TPKN 22, OFKR 07, HNMX 09 BASKI PABUCU / CLAMP / PRATZE (M8x10)
	ACK-12	C-SİSTEM için / For C-SYSTEM / FÜR C-SYSTEM CTSPR KARTUŞ BASKI PABUCU / CARTRIDGE CLAMP PRATZE FÜR KASSETTE
	ACK-15	S-SİSTEM FREZELEME için / For S-SYSTEM MILLING S-SYSTEM FÜR FRÄSER RD.. 10-12 BASKI PABUCU / CLAMP / PRATZE
	ACK-19	S-SİSTEM FREZELEME için / For S-SYSTEM MILLING S-SYSTEM FÜR FRÄSER WD0805D BASKI PABUCU / CLAMP / PRATZE
	ACK-23	C-SİSTEM için / For C-SYSTEM / FÜR C-SYSTEM SERAMİK DNGN 11, YEDEK TAKIMI SPARE PART SET of CERAMIC DNGN 11 ERSATZTEILSATZ FÜR KERAMIK DNGN 11
	ACK-24	S-SİSTEM FREZELEME için / For S-SYSTEM MILLING S-SYSTEM FÜR FRÄSER XD0806D BASKI PABUCU / CLAMP / PRATZE
	ACK-26	C-SİSTEM için / For C-SYSTEM / FÜR C-SYSTEM XNMU 0806.. BASKI PABUCU / CLAMP / PRATZE
	ACK-27	C-SİSTEM için / For C-SYSTEM / FÜR C-SYSTEM RCGX 06 BASKI PABUCU / CLAMP / PRATZE
	ACK-28	C-SİSTEM için / For C-SYSTEM / FÜR C-SYSTEM RCGX 09 BASKI PABUCU / CLAMP / PRATZE
	ACK-29	C-SİSTEM için / For C-SYSTEM / FÜR C-SYSTEM RCGX 12 BASKI PABUCU / CLAMP / PRATZE

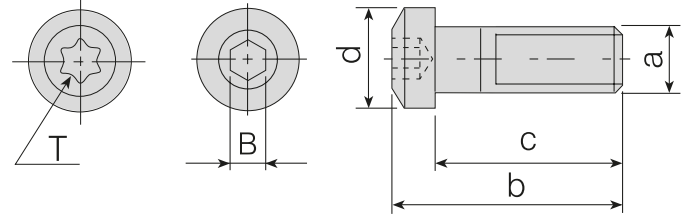

Takım Kodu Ordering Code Bestell-Bezeichnung	BASKI PABUÇ VİDALARI / CLAMP SCREWS / SCHRAUBEN FÜR PRATZEN					Ürün Detayı / Product Detail / Produkt-Details
	a (M)	b	c	d	B(T)	
AKV-01-M5X22	M5x0.8	25.1	22	11	3	T-SİSTEM için / For T-SYSTEM / FÜR T-SYSTEM DNMG 11, WNMG 06, TNMG 16
AKV-02-M6X22	M6x1.0	25.3	22	11	3	T-SİSTEM için / For T-SYSTEM / FÜR T-SYSTEM CNMG 12, WNMG 08, TNMG 22, DNMG 15, SNMG 12, VNMG 16
						M-SİSTEM için / For M-SYSTEM / FÜR M-SYSTEM TNMG 16, TNMG 22
AKV-03-M6X22	M6x1.0	25.3	22	10	3	M-SİSTEM için / For M-SYSTEM / FÜR M-SYSTEM WNMG 08
						KANAL KATERİ için / For EXTERNAL GROOVING FÜR STECHWERKZEUGE 2mm Dış Çap Kanal Kater Vidası / External Grooving Tools Screw 2 mm Schraube für Außen-Stechwerkzeuge
AKV-04-M5X17	M5x0.8	20	17	8.5	3	M-SİSTEM için / For M-SYSTEM / FÜR M-SYSTEM S20R MT-NR/L 16, S20R-S25S MWLN/R/L 06, S25S MDUNR/L 11-Dış Çap / External / AUßEN MWLN/R 06
AKV-05-M6X25	M6x1.0	29.5	25	13.8	4	T-SİSTEM için / For T-SYSTEM / FÜR T-SYSTEM Eski Ürün Vidası / Old Products Screws / Schraube für altes Produkt CNMG 16, SNMG 15
AKV-06-M6X20	M6x1.0	26.5	20	10.6	4	C-SİSTEM için / For C-SYSTEM / FÜR C-SYSTEM KNUX 16
AKV-07-M6X22	M6x1.0	23.5	22	8.5	3	C-SİSTEM için / For C-SYSTEM / FÜR C-SYSTEM ADKT-154.91, AIKT-154.91-R/L-32
AKV-10-M6X14	M6x1.0	16	14	8.8	4	C-SİSTEM için / For C-SYSTEM / FÜR C-SYSTEM AIKT-154.91-R/L-16, AIKT-154.91-R/L-20, AIKT-154.91-R/L-25
AKV-11-M8X29	M8x1.25	33.6	29	11	4	C-SİSTEM için / For C-SYSTEM / FÜR C-SYSTEM TNGN 16, CNGN 12, DNGN 15, SNGN 12
AKV-17-M5X15	M5x0.8	18	15	8.55	3	M-SİSTEM için / For M-SYSTEM / FÜR M-SYSTEM S16P MWLN/R/L 06
AKV-19-M7X25	M7x1.0	29.6	25	14	4	T-SİSTEM için / For T-SYSTEM / FÜR T-SYSTEM Yeni / New / Neu CNMG 16, SNMG 15
AKV-20-M6X19	M6x1.0	22	19	11	3	M-SİSTEM için / For M-SYSTEM / FÜR M-SYSTEM S25S MDUNR/L 15
AKV-21-M6X18	M6x1.0	20	18	8.5	3	C-SİSTEM için / For C-SYSTEM / FÜR C-SYSTEM AIKT-154.91-R/L-25
AKV-23-M4X10	M4x0.7	12.2	10	7.4	15	KARTUŞ için / For CARTRIDGE/ FÜR KASSETTE MONTAJ VİDASI / MOUNTING SCREW / BEFESTIGUNGSSCHRAUBE
AKV-27-M6X20	M6x1.0	23.3	20	10	3	M-SİSTEM için / For M-SYSTEM / FÜR M-SYSTEM S25S MWLN/R/L 08

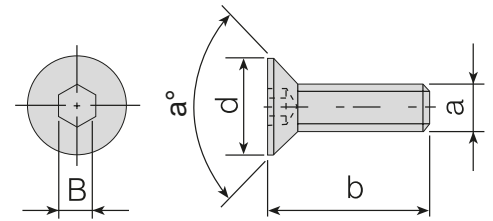

Takım Kodu Ordering Code Bestell-Bezeichnung	ALTLİK VİDALARI / SHIM SCREWS / SCHRAUBE FÜR UNTERLAGE					Ürün Detayı / Product Detail / Produkt-Details
	a (M)	b	d	B	a°	
AAV-01-M3x10	M3x0.5	10	5.9	2	90°	T-SİSTEM için / For T-SYSTEM / FÜR T-SYSTEM WNMG 06, KNUX 16
AAV-02-M5X12	M5x0.8	12	7	3	56°	T-SİSTEM için / For T-SYSTEM / FÜR T-SYSTEM CNMG 12, WNMG 08, TNMG 22, DNMG 15, SNMG 12
AAV-05-M6X15	M6x1.0	16	9	4	60°	T-SİSTEM için / For T-SYSTEM / FÜR T-SYSTEM CNMG 16, SNMG 15
AKV-12-M5X12	M5x0.8	12	7.8	3	90°	C-SİSTEM için / For C-SYSTEM / FÜR C-SYSTEM CTSPR Baskı Pabuç Vidası / Clamp Screw / Klemmschraube
AKV-16-M6X16	M6x1.0	16	10	4	76°	C-SİSTEM için / For C-SYSTEM / FÜR C-SYSTEM CTFPR 13CS 16 Baskı Pabuç Vidası / Clamp Screw / Klemmschraube
AAV-13-M5X8	M5x0.8	8	7	3	56°	T-SİSTEM için / For T-SYSTEM / FÜR T-SYSTEM S25S TSKNR/L 12, S25S TCLNR/L 12, S25S TWLNR/L 08, S25S TDUNR/L 15
AAV-14-M5X14	M5x0.8	14	8.8	3	45°	ADCR için / For ADCR / FÜR ADCR ADCR Montaj Vidası / Mounting Screw / ADCR BEFESTIGUNGSSCHRAUBE

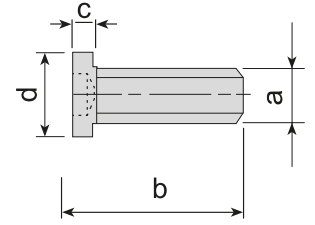
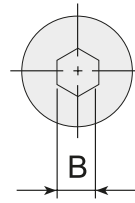

ALTİK VİDALARI / SHIM SCREWS / SCHRAUBE FÜR UNTERLAGE

Takım Kodu Ordering Code Bestell-Bezeichnung	a (M)	b	c	d	B	Ürün Detayı / Product Detail / Produkt-Details	
						T-SİSTEM için / For T-SYSTEM / FÜR T-SYSTEM	C-SİSTEM için / For C-SYSTEM / FÜR C-SYSTEM
AAV-03-M5X12	M5X0.8	12	1.4	6	3	T-SİSTEM için / For T-SYSTEM / FÜR T-SYSTEM	TNMG 16
						C-SİSTEM için / For C-SYSTEM / FÜR C-SYSTEM	TNGN 16
AAV-04-M5X12	M5X0.8	12	1.2	6.5	3	T-SİSTEM için / For T-SYSTEM / FÜR T-SYSTEM	VNMG 16, DNMG 11, CNMG 09
AAV-09-M5X9	M5X0.8	9	1.4	6	3	T-SİSTEM için / For T-SYSTEM / FÜR T-SYSTEM	S25S TCLNR/L 09, S25S TDUNR/L 11, S25S TDQNR/L 11

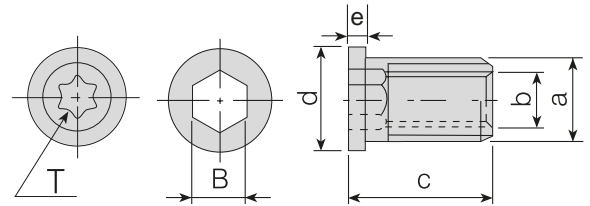

BUKSE VİDALAR / BUKSE SCREWS / SCHRAUBE FÜR UNTERLAGE

Takım Kodu Ordering Code Bestell-Bezeichnung	a (M)	b	c	d	B(T)	e	Ürün Detayı / Product Detail / Produkt-Details	
							S-SİSTEM için / For S-SYSTEM / FÜR S-SYSTEM	CCMT 09, DCMT 11, VBMT 16, VCMT 16, TCMT 16, SCMT 09, 16 ER/L, 16 IR/L
AAV-06-M3.5X11	M5x0.5	M3.5x0.6	11.3	6	3.5	1.2	S-SİSTEM için / For S-SYSTEM / FÜR S-SYSTEM	CCMT 09, DCMT 11, VBMT 16, VCMT 16, TCMT 16, SCMT 09, 16 ER/L, 16 IR/L
AAV-07-M4.5X13	M6X0.75	M4.5X0.75	13	7.5	4.5	1.6	S-SİSTEM için / For S-SYSTEM / FÜR S-SYSTEM	CCMT 12, SCMT 12, 22 ER/L, 22 IR/L
AAV-08-M3.5X8	M5X0.5	M3.5X0.6	8	6	20	1.2	S-SİSTEM için / For S-SYSTEM / FÜR S-SYSTEM	Ø25 DCMT 11, Ø25-Ø32 CCMT 09, Ø25 TCMT 16, S25S-S32T SVJBR/L 16,
AAV-10-M4.5X8	M6X0.75	M4.5X0.75	8	7.5	4.5	1.05	S-SİSTEM için / For S-SYSTEM / FÜR S-SYSTEM	Ø25-Ø32 CCMT 12, Ø25-Ø32 SCMT 12, SSDCN 1616 H12, SSSCR/L 1616 H12, SIR/L S25R 22
AAV-16-M3.5X8	M5X0.5	M3.5X0.6	8	6	20	1.1	S-SİSTEM için / For S-SYSTEM / FÜR S-SYSTEM	SEMT 13

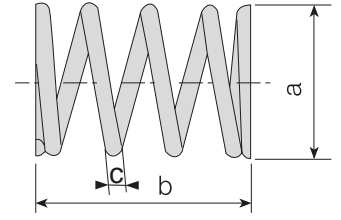
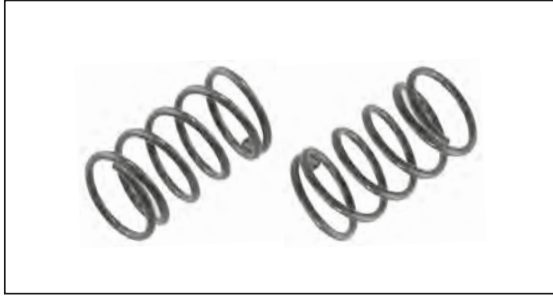

				BASKI YAYI / CLAMP SPRING / FEDER FÜR KLEMME	
Takım Kodu Ordering Code Bestell-Bezeichnung	a	b	c	Ürün Detayı / Product Detail / Produkt-Details	
AKY-01	7.7	11.2	0.9	T-SİSTEM için / For T-SYSTEM / FÜR T-SYSTEM	CNMG 12, WNMG 08, TNMG 22, DNMG 15, SNMG 12, VNMG 16
AKY-02	8.5	13.5	0.7	C-SİSTEM için / For C-SYSTEM / FÜR C-SYSTEM	KNUX 16

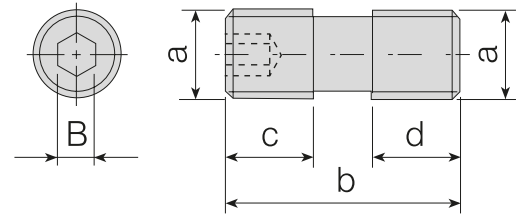

						BASKI PABUÇ VIDALARI / CLAMP SCREWS / SCHRAUBEN FÜR PRATZEN	
Takım Kodu Ordering Code Bestell-Bezeichnung	a (M)	b	c	d	B	Ürün Detayı / Product Detail / Produkt-Details	
AKV-13-M8X1X16	M8x1.0	16	6.8	6.8	4	C-SİSTEM FREZELEME için / MILLING For C- SYSTEM / C-SYSTEM FÜR FRÄSER	SPKN 12, Ø63 TPKN 16
AKV-14-M8X1X18	M8x1.0	18	8	8	4	C-SİSTEM FREZELEME için / MILLING For C- SYSTEM / C-SYSTEM FÜR FRÄSER	Ø80-Ø100 TPKN 16, Ø63-Ø315 TPKN 22
AKV-15-M8X1X20	M8x1.0	20	8.5	8.5	4	C-SİSTEM FREZELEME için / MILLING For C- SYSTEM / C-SYSTEM FÜR FRÄSER	OFKR 07, HNMX 09
AKV-18-M5X14	M5x0.8	15	5	6.8	2.5	C-SİSTEM FREZELEME için / MILLING For C- SYSTEM / C-SYSTEM FÜR FRÄSER	SN19
AKV-22-M8X1X14	M8x1.0	14	6.8	4.8	4	C-SİSTEM FREZELEME için / MILLING For C- SYSTEM / C-SYSTEM FÜR FRÄSER	Ø50 TPKN 16
AKV-26-M6X0.75X20	M6x0.75	20	8.5	8.5	3	C-SİSTEM FREZELEME için / MILLING For C- SYSTEM / C-SYSTEM FÜR FRÄSER	AFM45C-XN0806

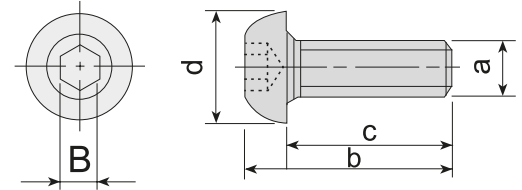

KANAL KATER ve MANTAR VİDALAR / GROOVING TOOL and CLAMP SCREWS / KLEMMSCHRAUBEN

Takım Kodu Ordering Code Bestell-Bezeichnung	a (M)	b	c	d	B	Ürün Detayı / Product Detail / Produkt-Details
1904-M8X1X20	M8X1.0	25.9	20	11.3	4	S-SİSTEM için / For S-SYSTEM / FÜR S-SYSTEM RCMT 32 Sıkma Vidası / Clamp Screw / Klemmschraube
2004-M8X1X20	M8X1.0	25.9	20	11.4	4	KANAL KATER için / For EXTERNAL GROOVING / FÜR TNMG-16, TNMG-22 BOHRSTANGE Kanal Kater Vidası / External Grooving Tools Screw / SCHRAUBEN FÜR STECHHALTER
2004-M8X20	M8X1.25	30	25	25	4	KANAL KATER için / For EXTERNAL GROOVING / FÜR TNMG-16, TNMG-22 BOHRSTANGE Eski Kanal Kater Vidası / Old External Grooving Tools Screw Alte / Schraube für Stechhalter
AKV-08-M6X12	M6x1.0	17	12	14.3	4	C-SİSTEM FREZELEME için / MILLING For C-SYSTEM / C-SYSTEM FÜR FRÄSER Baskı ve Sıkma Vidası, Mantar Vida / Clamp Screw / Klemmschraube
AKV-09-M8X18	M8X1.0	24	18	17.2	5	C-SİSTEM FREZELEME için / MILLING For C-SYSTEM / C-SYSTEM FÜR FRÄSER Baskı ve Sıkma Vidası, Mantar Vida / Clamp Screw / Klemmschraube

LEVYELER / LEVERS / KNIEHEBEL

Ürün Resmi Product Picture Produkt-Bild	Ürün Kodu Product Code / Code	Ürün Detayı / Product Detail / Produkt-Details
	APL-01	P-SİSTEM için / For P-SYSTEM / FÜR P-SYSTEM CNMG 09, DNMG 11, SNMG 09, TNMG 16, WNMG 06 LEVYESİ / LEVER / KNIEHEBEL
	APL-02	P-SİSTEM için / For P-SYSTEM / FÜR P-SYSTEM CNMG 12, SNMG 12, TNMG 22, WNMG 08 LEVYESİ / LEVER / KNIEHEBEL
	APL-03	P-SİSTEM için / For P-SYSTEM / FÜR P-SYSTEM DNMG 15 LEVYESİ / LEVER / KNIEHEBEL
	APL-04	P-SİSTEM için / For P-SYSTEM / FÜR P-SYSTEM CNMG 16, SNMG 15 LEVYESİ / LEVER / KNIEHEBEL
	APL-05	P-SİSTEM için / For P-SYSTEM / FÜR P-SYSTEM CNMG 19, SNMG 19 LEVYESİ / LEVER / KNIEHEBEL
	APL-06	P-SİSTEM için / For P-SYSTEM / FÜR P-SYSTEM CNMG 25, SNMG 25 LEVYESİ / LEVER / KNIEHEBEL
	APL-07	P-SİSTEM için / For P-SYSTEM / FÜR P-SYSTEM S16P PCLNR/L 09 LEVYESİ / LEVER / KNIEHEBEL
	APL-08	P-SİSTEM için / For P-SYSTEM / FÜR P-SYSTEM S16P PTUNR/L 16 LEVYESİ / LEVER / KNIEHEBEL

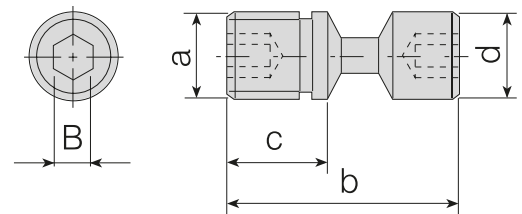

LEVYE VİDALARI / LEVER SCREWS / SCHRAUBEN FÜR KNIEHEBEL

Takım Kodu Ordering Code Bestell-Bezeichnung	a (M)	b	c	d	B	Ürün Detayı / Product Detail / Produkt-Details
ALV-01-M6X14	M6x1.0	14	10	5.85	2.5	P-SİSTEM için / For P-SYSTEM / FÜR P-SYSTEM S20R PCLNR/L 09, S20R PDUNR/L 11, S20R PDQNR/L 11, S20R PWNLR/L 06, S20R PTUNR/L 16
ALV-02-M6X17	M6x1.0	17	10	5.85	2.5	P-SİSTEM için / For P-SYSTEM / FÜR P-SYSTEM CNMG 09, DNMG 11, SNMG 09, TNMG 16, WNMG 06
ALV-03-M8X19	M8X1.0	19.8	11	7.9	3	P-SİSTEM için / For P-SYSTEM / FÜR P-SYSTEM CNMG 12, SNMG 12, TNMG 22, WNMG 08, DNMG 15
ALV-04-M8X22	M8X1.0	21.5	13	7.75	3	P-SİSTEM için / For P-SYSTEM / FÜR P-SYSTEM CNMG 16, SNMG 15
ALV-05-M10X27	M10X1.0	27.5	15	9.9	4	P-SİSTEM için / For P-SYSTEM / FÜR P-SYSTEM CNMG 19, SNMG 19
ALV-06-M12X36	M12X1.0	36	20	12	5	P-SİSTEM için / For P-SYSTEM / FÜR P-SYSTEM CNMG 25, SNMG 25
ALV-07-M6X13	M6X0.1	12.6	6.5	5.9	2.5	P-SİSTEM için / For P-SYSTEM / FÜR P-SYSTEM S16P PCLNR/L 09, S16P PTUNR/L 16
ALV-08-M8X16	M8X1.0	16	10	7.9	3	P-SİSTEM için / For P-SYSTEM / FÜR P-SYSTEM S25S PCLNR/L 12, S25S PDUNR/L 15, S25S PSKNR/L 12

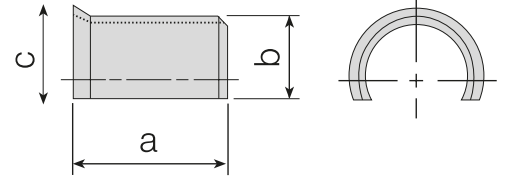

Takım Kodu Ordering Code Bestell-Bezeichnung	ALTLIK YAYLARI / SHIM SPRINGS / BEFESTIGUNGSFEDER			Ürün Detayı / Product Detail / Produkt-Details
	a	b	c	
AA-Y-01	5.6	4.9	6	P-SİSTEM için / For P-SYSTEM / FÜR P-SYSTEM CNMG 09 ,DNMG 11 ,SNMG 09 ,TNMG 16 ,WNMG 06
AA-Y-02	6	6.9	7.9	P-SİSTEM için / For P-SYSTEM / FÜR P-SYSTEM CNMG 12 ,SNMG 12 ,TNMG 22 ,WNMG 08 ,DNMG 15
AA-Y-03	8.9	8	9.5	P-SİSTEM için / For P-SYSTEM / FÜR P-SYSTEM CNMG 16 ,SNMG 15
AA-Y-04	11	9.8	10.7	P-SİSTEM için / For P-SYSTEM / FÜR P-SYSTEM CNMG 19 ,SNMG 19
AA-Y-05	12	13	15	P-SİSTEM için / For P-SYSTEM / FÜR P-SYSTEM CNMG 25 ,SNMG 25

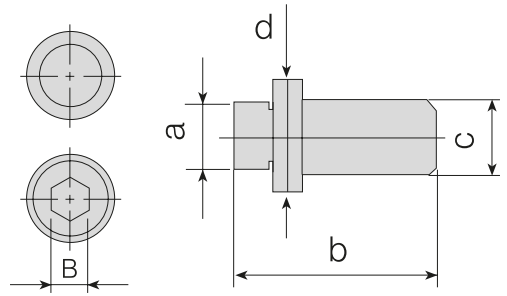

Takım Kodu Ordering Code Bestell-Bezeichnung	PİMLER / PINS / STIFT					Ürün Detayı / Product Detail / Produkt-Details
	a	b	c	d	B	
APM-01	3.55	18	5	6	-	M-SİSTEM için / For M-SYSTEM / FÜR T-SYSTEM Delik İçi / Internal / Intern Ø32-Ø40 TNMG 16 Dış Çap / External / Externe TNMG 16
APM-02	5	18	6	7.3	-	M-SİSTEM için / For M-SYSTEM / FÜR T-SYSTEM TNMG 22 , WNMG 08
APM-03	3.5	12	5	6.5	-	M-SİSTEM için / For M-SYSTEM / FÜR T-SYSTEM S20R MTFNR/L 16 , S20R MT-NR/L 16 , S20R MTUNR/L 16 , S20R MTQNR/L 16 , S20R MDUNR/L 11
APM-04	5	15	6	7.3	-	M-SİSTEM için / For M-SYSTEM / FÜR T-SYSTEM S32T MCLNR/L 12 , DNMG 15 , S25S MWLNR/L 08
APM-05	5	11.5	6.5	6.5	3	M-SİSTEM için / For M-SYSTEM / FÜR T-SYSTEM MSYNR 11.5CS 12 Kartuş için / for Cartridge / FÜR KASSETTE
APM-06	3	15.7	-	-	-	C-SİSTEM için / For C-SYSTEM / FÜR T-SYSTEM 154.91
APM-07	3.5	11.5	6.5	6.5	3	M-SİSTEM için / For M-SYSTEM / FÜR T-SYSTEM S20R ET-NR 16
APM-08	3.5	12	5	5.4	-	M-SİSTEM için / For M-SYSTEM / FÜR T-SYSTEM S25S MWLNR/L 06 , Dış Çap / External / Externe
APM-09	3.5	10	5	5.4	-	M-SİSTEM için / For M-SYSTEM / FÜR T-SYSTEM S16P MWLNR/L 06
APM-10	3.5	11	5	5.4	-	M-SİSTEM için / For M-SYSTEM / FÜR T-SYSTEM S20R MWLNR/L 06
APM-11	3.5	11	5	6.5	-	M-SİSTEM için / For M-SYSTEM / FÜR T-SYSTEM S20R MTQNR/L 16
APM-12	5	12	6	7.3	-	M-SİSTEM için / For M-SYSTEM / FÜR T-SYSTEM S20R MCLNR/L 12 , S25S MCLNR/L 12-Z
APM-13	5	14	6	7.3	-	M-SİSTEM için / For M-SYSTEM / FÜR T-SYSTEM S25S MCLNR/L 12
APM-14	3.55	15	5	6	-	M-SİSTEM için / For M-SYSTEM / FÜR T-SYSTEM S25S MTFNR/L 16 , S25S MT-NR/L 16 , S25S MTUNR/L 16 , S25S MTQNR/L 16
APM-15	4.40	16	6.40	6.40	3	M-SİSTEM için / For M-SYSTEM / FÜR T-SYSTEM MSYNR 16CS 12 Kartuş için / for Cartridge / FÜR KASSETTE

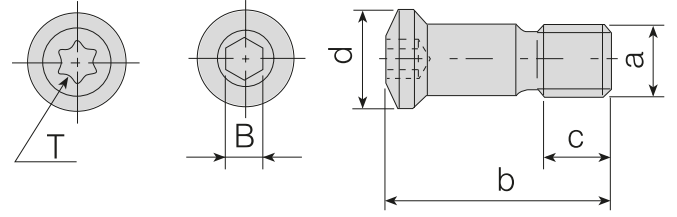

KÜRESEL FİNİŞ VİDALARI / BALL NOSE SCREWS / SCHRAUBEN FÜR KUGELKOPFFRÄSER							
Takım Kodu Ordering Code Bestell-Bezeichnung	a (M)	b	c	d	B(T)	Ürün Detayı / Product Detail / Produkt-Details	
1208-M3x7	M3x0.5	6.9	2.7	4.1	8	KÜRESEL FREZE VİDASI / BALL NOSE SCREW / SCHRAUBE FÜR KUGELFRÄSER	P3208
1215-M4X0.5X9	M4X0.5	8.6	3.2	5.75	15	KÜRESEL FREZE VİDASI / BALL NOSE SCREW / SCHRAUBE FÜR KUGELFRÄSER	P3210-ROHX 12
1220-M5X0.5X9	M5X0.5	9.6	3.4	6.8	20	KÜRESEL FREZE VİDASI / BALL NOSE SCREW / SCHRAUBE FÜR KUGELFRÄSER	P3212
1220-M5X0.5X12	M5X0.5	12.9	4.4	7.4	20	KÜRESEL FREZE VİDASI / BALL NOSE SCREW / SCHRAUBE FÜR KUGELFRÄSER	P3216-ROHX 16
1220-M5X0.5X15	M5X0.5	16.4	6	7.8	20	KÜRESEL FREZE VİDASI / BALL NOSE SCREW / SCHRAUBE FÜR KUGELFRÄSER	P3220-ROHX 20
1220-M6X0.75X20	M6X0.75	20	6	9.4	20	KÜRESEL FREZE VİDASI / BALL NOSE SCREW / SCHRAUBE FÜR KUGELFRÄSER	P3225
1204-M8X0.75X26	M8X0.75	26	7.5	12	4	KÜRESEL FREZE VİDASI / BALL NOSE SCREW / SCHRAUBE FÜR KUGELFRÄSER	P3232
1210-M3.5X9.6	M3.5X0.6	9.6	4	4.7	10	KÜRESEL FREZE VİDASI / BALL NOSE SCREW / SCHRAUBE FÜR KUGELFRÄSER	BNM 12
1215-M4X13.5	M4X0.7	13.5	5	5.8	15	KÜRESEL FREZE VİDASI / BALL NOSE SCREW / SCHRAUBE FÜR KUGELFRÄSER	BNM 16

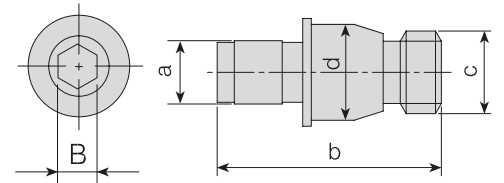
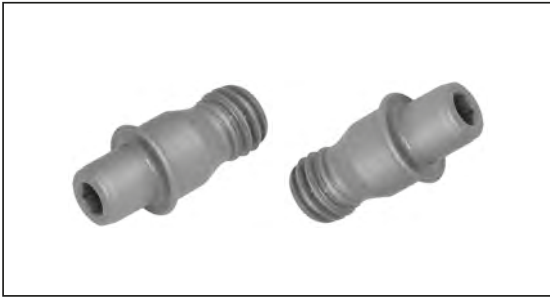

EKSANTRİK VİDA / ECCENTRIC SCREW / EXZENTERSCHRAUBEN						
Takım Kodu Ordering Code Bestell-Bezeichnung	a	b	c	d	B	Ürün Detayı / Product Detail / Produkt-Details
AEV-01-M6x16	4.85	16	M6x1.0	6.5	2.5	Eksantrik Vida / Eccentric Screw / EXZENTERSCHRAUBEN PSDNN Kartuş için / for Cartridge / FÜR KASSETTE

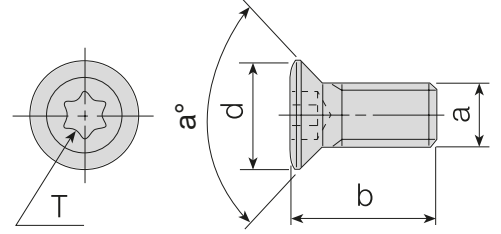

TORK VİDALARI / TORX SCREWS / TORX-SCHRAUBEN

Takım Kodu Ordering Code Bestell-Bezeichnung	a (M)	b	T	d	a°	Ürün Detayı / Product Detail / Produkt-Details	
4006-M1.6x3.2	M1.6X0.35	3.2	6	2.50	60	S-SİSTEM için / For S-SYSTEM / FÜR S-SYSTEM	TORK VİDA / TORX SCREW / TORX-SCHRAUBEN
3006-M1.8x4	M1.8X0.35	4	6	2.45	60	S-SİSTEM için / For S-SYSTEM / FÜR S-SYSTEM	TORK VİDA / TORX SCREW / TORX-SCHRAUBEN
3006-M2x4	M2X0.4	4.3	6	2.7	60	S-SİSTEM için / For S-SYSTEM / FÜR S-SYSTEM	TORK VİDA / TORX SCREW / TORX-SCHRAUBEN
4006-M2x5	M2X0.4	5	6	3	55	S-SİSTEM için / For S-SYSTEM / FÜR S-SYSTEM	TORK VİDA / TORX SCREW / TORX-SCHRAUBEN
3007-M2.2x5	M2.2X0.45	5.2	7	3.15	60	S-SİSTEM için / For S-SYSTEM / FÜR S-SYSTEM	TORK VİDA / TORX SCREW / TORX-SCHRAUBEN
4006-M2.2x5	M2.2X0.45	5	6	2.8	55	S-SİSTEM için / For S-SYSTEM / FÜR S-SYSTEM	TORK VİDA / TORX SCREW / TORX-SCHRAUBEN
1008-M2.5x5	M2.5X0.45	5.5	8	3.5	45	S-SİSTEM için / For S-SYSTEM / FÜR S-SYSTEM	TORK VİDA / TORX SCREW / TORX-SCHRAUBEN
1008-M2.5x7	M2.5X0.45	7	8	3.6	45	S-SİSTEM için / For S-SYSTEM / FÜR S-SYSTEM	TORK VİDA / TORX SCREW / TORX-SCHRAUBEN
1108-M2.5x6	M2.5X0.45	6	8	3.9	R	S-SİSTEM için / For S-SYSTEM / FÜR S-SYSTEM	TORK VİDA / TORX SCREW / TORX-SCHRAUBEN
3008-M2.5x5	M2.5X0.45	5	8	3.5	60	S-SİSTEM için / For S-SYSTEM / FÜR S-SYSTEM	TORK VİDA / TORX SCREW / TORX-SCHRAUBEN
3008-M2.5x6	M2.5X0.45	6	8	3.5	60	S-SİSTEM için / For S-SYSTEM / FÜR S-SYSTEM	TORK VİDA / TORX SCREW / TORX-SCHRAUBEN
4008-M2.5x4	M2.5X0.45	4	8	3.5	45	S-SİSTEM için / For S-SYSTEM / FÜR S-SYSTEM	TORK VİDA / TORX SCREW / TORX-SCHRAUBEN
4008-M2.5x4.5	M2.5X0.45	4.5	8	3.5	45	S-SİSTEM için / For S-SYSTEM / FÜR S-SYSTEM	TORK VİDA / TORX SCREW / TORX-SCHRAUBEN
4008-M2.5x6	M2.5X0.45	5.8	8	3.5	45	S-SİSTEM için / For S-SYSTEM / FÜR S-SYSTEM	TORK VİDA / TORX SCREW / TORX-SCHRAUBEN
4008-M2.5x6.5	M2.5X0.45	6.5	8	4	60	S-SİSTEM için / For S-SYSTEM / FÜR S-SYSTEM	TORK VİDA / TORX SCREW / TORX-SCHRAUBEN
4108-M2.5x6.5	M2.5X0.45	6.5	8	3.5	50	S-SİSTEM için / For S-SYSTEM / FÜR S-SYSTEM	TORK VİDA / TORX SCREW / TORX-SCHRAUBEN
4108-M2.5x8	M2.5X0.45	8	8	3.5	50	S-SİSTEM için / For S-SYSTEM / FÜR S-SYSTEM	TORK VİDA / TORX SCREW / TORX-SCHRAUBEN
1008-M3x6	M3X0.5	6	8	4	60	S-SİSTEM için / For S-SYSTEM / FÜR S-SYSTEM	TORK VİDA / TORX SCREW / TORX-SCHRAUBEN
1008-M3x8	M3X0.5	8	8	3.9	60	S-SİSTEM için / For S-SYSTEM / FÜR S-SYSTEM	TORK VİDA / TORX SCREW / TORX-SCHRAUBEN
1108-M3x6.8	M3X0.5	6.8	8	4	60	S-SİSTEM için / For S-SYSTEM / FÜR S-SYSTEM	TORK VİDA / TORX SCREW / TORX-SCHRAUBEN
3008-M3x6	M3X0.5	6	8	4	45	S-SİSTEM için / For S-SYSTEM / FÜR S-SYSTEM	TORK VİDA / TORX SCREW / TORX-SCHRAUBEN
3008-M3x7	M3X0.5	7	8	4	55	S-SİSTEM için / For S-SYSTEM / FÜR S-SYSTEM	TORK VİDA / TORX SCREW / TORX-SCHRAUBEN
3008-M3x8	M3X0.5	8	8	4	45	S-SİSTEM için / For S-SYSTEM / FÜR S-SYSTEM	TORK VİDA / TORX SCREW / TORX-SCHRAUBEN
3108-M3x6	M3X0.5	6	8	3.8	60	S-SİSTEM için / For S-SYSTEM / FÜR S-SYSTEM	TORK VİDA / TORX SCREW / TORX-SCHRAUBEN
3108-M3x8	M3X0.5	8	8	3.8	60	S-SİSTEM için / For S-SYSTEM / FÜR S-SYSTEM	TORK VİDA / TORX SCREW / TORX-SCHRAUBEN
4008-M3x8	M3X0.5	8	8	4	60	S-SİSTEM için / For S-SYSTEM / FÜR S-SYSTEM	TORK VİDA / TORX SCREW / TORX-SCHRAUBEN
4010-M3x6	M3X0.5	6	10	4.2	45	S-SİSTEM için / For S-SYSTEM / FÜR S-SYSTEM	TORK VİDA / TORX SCREW / TORX-SCHRAUBEN
4010-M3x8	M3X0.5	8	10	4.2	45	S-SİSTEM için / For S-SYSTEM / FÜR S-SYSTEM	TORK VİDA / TORX SCREW / TORX-SCHRAUBEN
1015-M3.5x9	M3.5X0.6	9	15	5.3	60	S-SİSTEM için / For S-SYSTEM / FÜR S-SYSTEM	TORK VİDA / TORX SCREW / TORX-SCHRAUBEN
1015-M3.5x11	M3.5X0.6	11.1	15	5.3	60	S-SİSTEM için / For S-SYSTEM / FÜR S-SYSTEM	TORK VİDA / TORX SCREW / TORX-SCHRAUBEN
1015-M3.5x14	M3.5X0.6	14	15	5.3	66	S-SİSTEM için / For S-SYSTEM / FÜR S-SYSTEM	TORK VİDA / TORX SCREW / TORX-SCHRAUBEN
1015-M3.5x16	M3.5X0.6	16	15	5.3	55	S-SİSTEM için / For S-SYSTEM / FÜR S-SYSTEM	TORK VİDA / TORX SCREW / TORX-SCHRAUBEN
1315-M3.5x11	M3.5X0.6	10.6	15	7.9	-	S-SİSTEM için / For S-SYSTEM / FÜR S-SYSTEM	TORK VİDA / TORX SCREW / TORX-SCHRAUBEN
1510-M3.5x7	M3.5X0.6	7.1	10	5.1	55	S-SİSTEM için / For S-SYSTEM / FÜR S-SYSTEM	TORK VİDA / TORX SCREW / TORX-SCHRAUBEN
1510-M3.5x9	M3.5X0.6	9.1	10	5	55	S-SİSTEM için / For S-SYSTEM / FÜR S-SYSTEM	TORK VİDA / TORX SCREW / TORX-SCHRAUBEN
1615-M3.5x10	M3.5X0.6	10	15	5.8	60	S-SİSTEM için / For S-SYSTEM / FÜR S-SYSTEM	TORK VİDA / TORX SCREW / TORX-SCHRAUBEN
1615-M3.5x11	M3.5X0.6	11	15	5.8	60	S-SİSTEM için / For S-SYSTEM / FÜR S-SYSTEM	TORK VİDA / TORX SCREW / TORX-SCHRAUBEN
1615-M3.5x15	M3.5X0.6	15	15	5.8	60	S-SİSTEM için / For S-SYSTEM / FÜR S-SYSTEM	TORK VİDA / TORX SCREW / TORX-SCHRAUBEN
3010-M3.5x7	M3.5X0.6	7	10	5	55	S-SİSTEM için / For S-SYSTEM / FÜR S-SYSTEM	TORK VİDA / TORX SCREW / TORX-SCHRAUBEN
3010-M3.5x9	M3.5X0.6	9	10	5	55	S-SİSTEM için / For S-SYSTEM / FÜR S-SYSTEM	TORK VİDA / TORX SCREW / TORX-SCHRAUBEN
3015-M3.5x9	M3.5X0.6	8.8	15	5.4	60	S-SİSTEM için / For S-SYSTEM / FÜR S-SYSTEM	TORK VİDA / TORX SCREW / TORX-SCHRAUBEN
4015-M3.5x8	M3.5X0.6	7.9	15	5.3	55	S-SİSTEM için / For S-SYSTEM / FÜR S-SYSTEM	TORK VİDA / TORX SCREW / TORX-SCHRAUBEN
4015-M3.5x9	M3.5X0.6	8.7	15	5.3	60	S-SİSTEM için / For S-SYSTEM / FÜR S-SYSTEM	TORK VİDA / TORX SCREW / TORX-SCHRAUBEN
4015-M3.5x10	M3.5X0.6	9.8	15	5.3	60	S-SİSTEM için / For S-SYSTEM / FÜR S-SYSTEM	TORK VİDA / TORX SCREW / TORX-SCHRAUBEN
4015-M3.5x11	M3.5X0.6	10.7	15	5.3	60	S-SİSTEM için / For S-SYSTEM / FÜR S-SYSTEM	TORK VİDA / TORX SCREW / TORX-SCHRAUBEN

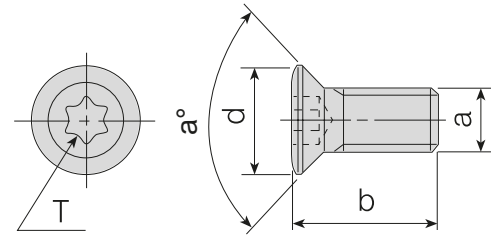
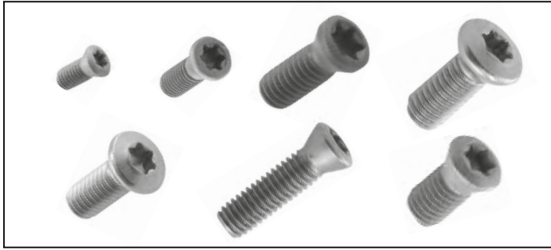

TORK VİDALARI / TORX SCREWS / TORX-SCHRAUBEN

Takım Kodu Ordering Code Bestell-Bezeichnung	a (M)	b	T	d	a°	Ürün Detayı / Product Detail / Produkt-Details	
4015-M3.5x12	M3.5X0.6	12	15	5.3	60	S-SİSTEM için / For S-SYSTEM / FÜR S-SYSTEM	TORK VİDA / TORX SCREW / TORX-SCHRAUBEN
4015-M3.5x14	M3.5X0.6	13.7	15	5.3	60	S-SİSTEM için / For S-SYSTEM / FÜR S-SYSTEM	TORK VİDA / TORX SCREW / TORX-SCHRAUBEN
1015-M4x8	M4X0.7	8	15	6.8	R	S-SİSTEM için / For S-SYSTEM / FÜR S-SYSTEM	TORK VİDA / TORX SCREW / TORX-SCHRAUBEN
1015-M4x9	M4X0.7	9	15	6.8	R	S-SİSTEM için / For S-SYSTEM / FÜR S-SYSTEM	TORK VİDA / TORX SCREW / TORX-SCHRAUBEN
1515-M4x9	M4X0.7	9	15	5.7	50	S-SİSTEM için / For S-SYSTEM / FÜR S-SYSTEM	TORK VİDA / TORX SCREW / TORX-SCHRAUBEN
1015-M4x11	M4X0.7	10.8	15	6.8	R	S-SİSTEM için / For S-SYSTEM / FÜR S-SYSTEM	TORK VİDA / TORX SCREW / TORX-SCHRAUBEN
1115-M4x10	M4X0.7	10	15	5.9	R	S-SİSTEM için / For S-SYSTEM / FÜR S-SYSTEM	TORK VİDA / TORX SCREW / TORX-SCHRAUBEN
1315-M4x11	M4X0.7	11.1	15	5	45	S-SİSTEM için / For S-SYSTEM / FÜR S-SYSTEM	TORK VİDA / TORX SCREW / TORX-SCHRAUBEN
1415-M4x11	M4X0.7	11	15	5.6	50	S-SİSTEM için / For S-SYSTEM / FÜR S-SYSTEM	TORK VİDA / TORX SCREW / TORX-SCHRAUBEN
1515-M4x11	M4X0.7	11.1	15	5.6	50	S-SİSTEM için / For S-SYSTEM / FÜR S-SYSTEM	TORK VİDA / TORX SCREW / TORX-SCHRAUBEN
1615-M4x11	M4X0.7	11.1	15	6	50	S-SİSTEM için / For S-SYSTEM / FÜR S-SYSTEM	TORK VİDA / TORX SCREW / TORX-SCHRAUBEN
3015-M4x9	M4X0.7	9	15	5.6	50	S-SİSTEM için / For S-SYSTEM / FÜR S-SYSTEM	TORK VİDA / TORX SCREW / TORX-SCHRAUBEN
3015-M4x11	M4X0.7	11	15	5.6	50	S-SİSTEM için / For S-SYSTEM / FÜR S-SYSTEM	TORK VİDA / TORX SCREW / TORX-SCHRAUBEN
4015-M4x9	M4X0.7	9	15	5.6	50	S-SİSTEM için / For S-SYSTEM / FÜR S-SYSTEM	TORK VİDA / TORX SCREW / TORX-SCHRAUBEN
4015-M4x10	M4X0.7	10	15	5.6	50	S-SİSTEM için / For S-SYSTEM / FÜR S-SYSTEM	TORK VİDA / TORX SCREW / TORX-SCHRAUBEN
4015-M4x11	M4X0.7	11	15	5.6	50	S-SİSTEM için / For S-SYSTEM / FÜR S-SYSTEM	TORK VİDA / TORX SCREW / TORX-SCHRAUBEN
4015-M4x12	M4X0.7	12	15	5.7	50	S-SİSTEM için / For S-SYSTEM / FÜR S-SYSTEM	TORK VİDA / TORX SCREW / TORX-SCHRAUBEN
4115-M4x12	M4X0.7	12	15	5.6	55	S-SİSTEM için / For S-SYSTEM / FÜR S-SYSTEM	TORK VİDA / TORX SCREW / TORX-SCHRAUBEN
4515-M4x8	M4X0.7	8	15	5.1	50	S-SİSTEM için / For S-SYSTEM / FÜR S-SYSTEM	TORK VİDA / TORX SCREW / TORX-SCHRAUBEN
4515-M4x11	M4X0.7	11	15	5.1	50	S-SİSTEM için / For S-SYSTEM / FÜR S-SYSTEM	TORK VİDA / TORX SCREW / TORX-SCHRAUBEN
4615-M4x11	M4X0.7	11	15	6	50	S-SİSTEM için / For S-SYSTEM / FÜR S-SYSTEM	TORK VİDA / TORX SCREW / TORX-SCHRAUBEN
1015-M4.5x12	M4.5X0.75	12	15	6.6	50	S-SİSTEM için / For S-SYSTEM / FÜR S-SYSTEM	TORK VİDA / TORX SCREW / TORX-SCHRAUBEN
1020-M4.5x14	M4.5X0.75	14	20	6.5	45	S-SİSTEM için / For S-SYSTEM / FÜR S-SYSTEM	TORK VİDA / TORX SCREW / TORX-SCHRAUBEN
1020-M4.5x16	M4.5X0.75	16	20	6.5	45	S-SİSTEM için / For S-SYSTEM / FÜR S-SYSTEM	TORK VİDA / TORX SCREW / TORX-SCHRAUBEN
1120-M4.5x12	M4.5X0.75	12.1	20	7.9	R	S-SİSTEM için / For S-SYSTEM / FÜR S-SYSTEM	TORK VİDA / TORX SCREW / TORX-SCHRAUBEN
1515-M4.5x11	M4.5X0.75	11	15	6.4	45	S-SİSTEM için / For S-SYSTEM / FÜR S-SYSTEM	TORK VİDA / TORX SCREW / TORX-SCHRAUBEN
4015-M4.5x11	M4.5X0.75	11	15	6.4	45	S-SİSTEM için / For S-SYSTEM / FÜR S-SYSTEM	TORK VİDA / TORX SCREW / TORX-SCHRAUBEN
4020-M4.5x10	M4.5X0.75	10	20	6.5	55	S-SİSTEM için / For S-SYSTEM / FÜR S-SYSTEM	TORK VİDA / TORX SCREW / TORX-SCHRAUBEN
4020-M4.5x12	M4.5X0.75	12	20	6.5	55	S-SİSTEM için / For S-SYSTEM / FÜR S-SYSTEM	TORK VİDA / TORX SCREW / TORX-SCHRAUBEN
1020-M5x11	M5X0.8	11	20	6.6	50	S-SİSTEM için / For S-SYSTEM / FÜR S-SYSTEM	TORK VİDA / TORX SCREW / TORX-SCHRAUBEN
1020-M5x14	M5X0.8	14.1	20	6.8	50	S-SİSTEM için / For S-SYSTEM / FÜR S-SYSTEM	TORK VİDA / TORX SCREW / TORX-SCHRAUBEN
1120-M5x13	M5X0.8	13	20	7	R	S-SİSTEM için / For S-SYSTEM / FÜR S-SYSTEM	TORK VİDA / TORX SCREW / TORX-SCHRAUBEN
1615-M5x14	M5X0.8	14	15	7.3	50	S-SİSTEM için / For S-SYSTEM / FÜR S-SYSTEM	TORK VİDA / TORX SCREW / TORX-SCHRAUBEN
1620-M5x18	M5X0.8	18	20	8.15	50	S-SİSTEM için / For S-SYSTEM / FÜR S-SYSTEM	TORK VİDA / TORX SCREW / TORX-SCHRAUBEN
1620-M5x22	M5X0.8	22	20	8.15	50	S-SİSTEM için / For S-SYSTEM / FÜR S-SYSTEM	TORK VİDA / TORX SCREW / TORX-SCHRAUBEN
4420-M5x14	M5X0.8	14	20	6.60	60	S-SİSTEM için / For S-SYSTEM / FÜR S-SYSTEM	TORK VİDA / TORX SCREW / TORX-SCHRAUBEN
1020-M6x16	M6X1.0	16	20	8.5	50	S-SİSTEM için / For S-SYSTEM / FÜR S-SYSTEM	TORK VİDA / TORX SCREW / TORX-SCHRAUBEN
1420-M6x16	M6X1.0	16	20	7.6	50	S-SİSTEM için / For S-SYSTEM / FÜR S-SYSTEM	TORK VİDA / TORX SCREW / TORX-SCHRAUBEN
1520-M6x16	M6X1.0	16	20	8.2	50	S-SİSTEM için / For S-SYSTEM / FÜR S-SYSTEM	TORK VİDA / TORX SCREW / TORX-SCHRAUBEN
1710-U5-40x12.2	UNC 5-40	12.2	10	5.6	60	S-SİSTEM için / For S-SYSTEM / FÜR S-SYSTEM	TORK VİDA / TORX SCREW / TORX-SCHRAUBEN
1720-U8-32x10	UNC 8-32	10	20	7.5	60	S-SİSTEM için / For S-SYSTEM / FÜR S-SYSTEM	TORK VİDA / TORX SCREW / TORX-SCHRAUBEN
1720-U8-32x15	UNC 8-32	15	20	7.5	60	S-SİSTEM için / For S-SYSTEM / FÜR S-SYSTEM	TORK VİDA / TORX SCREW / TORX-SCHRAUBEN
1707-U4-48x6	UNF 4-48	6	7	3.27	60	S-SİSTEM için / For S-SYSTEM / FÜR S-SYSTEM	TORK VİDA / TORX SCREW / TORX-SCHRAUBEN
1707-U4-48x6.5	UNF 4-48	6.5	7	3.27	60	S-SİSTEM için / For S-SYSTEM / FÜR S-SYSTEM	TORK VİDA / TORX SCREW / TORX-SCHRAUBEN
1707-U4-48x8.2	UNF 4-48	8.2	7	3.27	60	S-SİSTEM için / For S-SYSTEM / FÜR S-SYSTEM	TORK VİDA / TORX SCREW / TORX-SCHRAUBEN

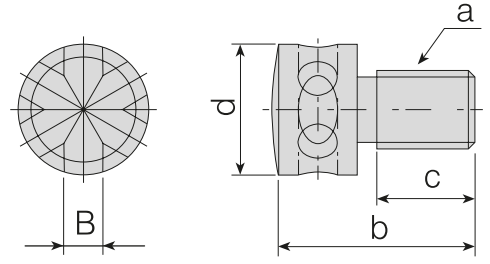

Takım Kodu Ordering Code Bestell-Bezeichnung	EKSENEL AYAR VİDALARI / AXIAL ADJUSTING SCREWS / AXIAL-EINSTELLSCHRAUBE					Ürün Detayı / Product Detail / Produkt-Details
	a (M)	b	c	d	B	
2600-M4x9.5	M4x0.5	5.5	4	4	1.5	Kartuş için / for Cartridge / FÜR KASSETTE
2600-M5x13	M5x0.5	12.8	7	8.7	2.5	Kartuş için / for Cartridge / FÜR KASSETTE
2600-M6x18	M6x1.0	18.2	9	10	3.5	Kartuş için / for Cartridge / FÜR KASSETTE

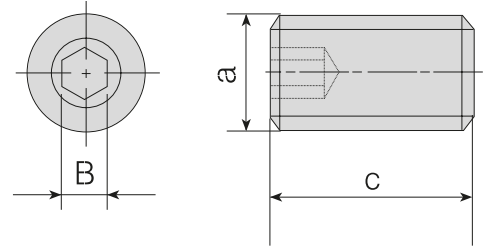
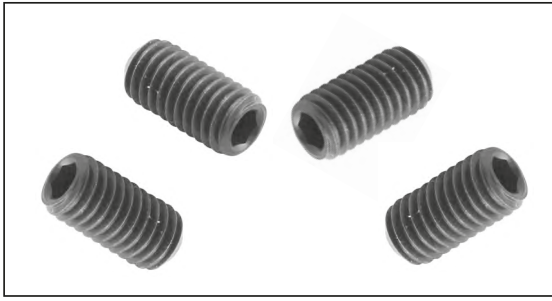

Takım Kodu Ordering Code Bestell-Bezeichnung	RADYAL AYAR VİDALARI / RADIAL ADJUSTING SCREWS / AXIAL-EINSTELLSCHRAUBE			Ürün Detayı / Product Detail / Produkt-Details
	a (M)	c	B	
2715-M3x4	M3x0.5	4	1.5	KABA BARA için / for ROUGH BORING HEADS FÜR SCHRUPP-SPINDELKOPF
2715-M3x5	M3x0.5	5	1.5	KABA BARA için / for ROUGH BORING HEADS FÜR SCHRUPP-SPINDELKOPF
2715-M3x8	M3x0.5	8	1.5	KABA BARA için / for ROUGH BORING HEADS FÜR SCHRUPP-SPINDELKOPF
2702-M4x4	M4x0.7	4	2	KARTUŞ için / for CARTRIDGE / FÜR KASSETTE
2702-M4x10	M4x0.7	10	2	KARTUŞ için / for CARTRIDGE / FÜR KASSETTE
2702-M4x12	M4x0.7	12	2	KABA BARA için / for ROUGH BORING HEADS FÜR SCHRUPP-SPINDELKOPF
2725-M5x6	M5x0.8	5	2.5	KARTUŞ için / for CARTRIDGE / FÜR KASSETTE
2725-M5x10	M5x0.8	10	2.5	KARTUŞ için / for CARTRIDGE / FÜR KASSETTE
2725-M5x12	M5x0.8	12	2.5	KABA BARA için / for ROUGH BORING HEADS FÜR SCHRUPP-SPINDELKOPF
2725-M5x14	M5x0.8	14	2.5	KABA BARA için / for ROUGH BORING HEADS FÜR SCHRUPP-SPINDELKOPF
2703-M6x16	M6x1	16	3	KABA BARA için / for ROUGH BORING HEADS FÜR SCHRUPP-SPINDELKOPF
2704-M8x25	M8x1.25	25.9	4	KABA BARA için / for ROUGH BORING HEADS FÜR SCHRUPP-SPINDELKOPF

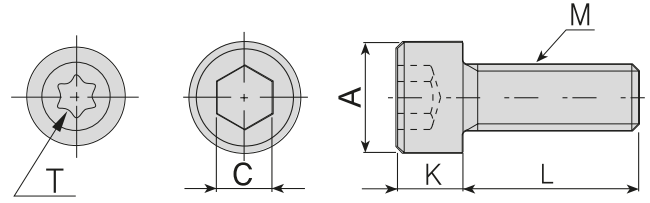

Takım Kodu
Ordering Code
Bestell-Bezeichnung

İNBUS ÇİVİTALAR / INBUS SCREWS / INNENSECHSKANT-SCHRAUBE

	M	A	C	K	L	Ürün Detayı / Product Detail / Produkt-Details	
2503-M4x10	M4x0.7	6.85	3	4	10	KANAL KATER VİDASI / SOME GROOVING TOOLS SCREW	SCHRAUBEN FÜR STECHHALTER
2525-M3X14	M3X0.5	5.4	2.5	2.9	14	BARA KARTUŞU için SIKMA VİDASI / for BORING HEADS CARTRIDGE SCREW	SCHRAUBE FÜR KASSETTE DER SCHRUPP-SPINDELKÖPFE
2503-M4X20	M4x0.7	7	3	3.9	20	BARA KARTUŞU için SIKMA VİDASI / for BORING HEADS CARTRIDGE SCREW	SCHRAUBE FÜR KASSETTE DER SCHRUPP-SPINDELKÖPFE
2503-M4X12	M4x0.7	6.85	3	4	12	KANAL KATER VİDASI / SOME GROOVING TOOLS SCREW	SCHRAUBEN FÜR STECHHALTER
2503-M4X15	M4x0.7	6.85	3	4	15	BARA KARTUŞU için SIKMA VİDASI / for BORING HEADS CARTRIDGE SCREW	SCHRAUBE FÜR KASSETTE DER SCHRUPP-SPINDELKÖPFE
2504-M5X16	M5X0.8	8.5	4	5	16	KANAL KATER VİDASI / SOME GROOVING TOOLS SCREW	SCHRAUBEN FÜR STECHHALTER
2504-M5X12	M5X0.8	8.5	4	5	12	KANAL KATER VİDASI / SOME GROOVING TOOLS SCREW	SCHRAUBEN FÜR STECHHALTER
2504-M5X25	M5X0.8	8.5	4	5	25	BARA KARTUŞU için SIKMA VİDASI / for BORING HEADS CARTRIDGE SCREW	SCHRAUBE FÜR KASSETTE DER SCHRUPP-SPINDELKÖPFE
2505-M6X16	M6X1	9.9	5	6	16	KANAL KATER VİDASI / SOME GROOVING TOOLS SCREW	SCHRAUBEN FÜR STECHHALTER
2505-M6X20	M6X1	9.9	5	6	20	KANAL KATER VİDASI / SOME GROOVING TOOLS SCREW	SCHRAUBEN FÜR STECHHALTER
2505-M6X25	M6X1	9.9	5	6	25	BLOK BASKI PABUÇ VİDASI / for BLOCK CLAMP SCREW	SCHRAUBE FÜR SPANNBLOCK
2505-M6X30	M6X1	9.9	5	6	30	BARA KARTUŞU için SIKMA VİDASI / for BORING HEADS CARTRIDGE SCREW	SCHRAUBE FÜR KASSETTE DER SCHRUPP-SPINDELKÖPFE
2405-M8X30	M8X1.25	13	5	5	30	A16 MONTAJ VİDASI (KAFASI KÜÇÜK) / MOUNTING SCREW (SMALL HEAD)	BEFESTIGUNGSSCHRAUBE (KLEINER KOPF)
2506-M8X20	M8X1.25	13	6	7.9	20	KARTUŞ MONTAJ VİDASI / CARTRIDGE MOUNTING SCREW	BEFESTIGUNGSSCHRAUBE FÜR KASSETTE
2506-M8X30	M8X1.25	13	6	7.9	30	A16 MONTAJ VİDASI / MOUNTING SCREW	BEFESTIGUNGSSCHRAUBE
2506-M8X35	M8X1.25	13	6	7.9	35	BARA KARTUŞU için SIKMA VİDASI / for BORING HEADS CARTRIDGE SCREW	SCHRAUBE FÜR KASSETTE DER SCHRUPP-SPINDELKÖPFE
2406-M8X30	M8X1.25	12	6	7.9	30	A16 MONTAJ VİDASI / MOUNTING SCREW	BEFESTIGUNGSSCHRAUBE
2407-M10X30	M10X1.5	16	7	6	30	A16 MONTAJ VİDASI / MOUNTING SCREW	BEFESTIGUNGSSCHRAUBE
2408-M10X30	M10X1.5	13.90	8	10	30	A22 MONTAJ VİDASI / MOUNTING SCREW	BEFESTIGUNGSSCHRAUBE
2508-M10X30	M10X1.5	16	8	10	30	A22 MONTAJ VİDASI / MOUNTING SCREW	BEFESTIGUNGSSCHRAUBE
2508-M10X40	M10X1.5	16	8	10	40	BARA KARTUŞU için SIKMA VİDASI / for BORING HEADS CARTRIDGE SCREWS	SCHRAUBE FÜR KASSETTE DER SCHRUPP-SPINDELKÖPFE
2408-M12X35	M12X1.75	18	8	7	35	A27 MONTAJ VİDASI / MOUNTING SCREW	BEFESTIGUNGSSCHRAUBE
2510-M12X35	M12X1.75	18	10	12	35	A27 MONTAJ VİDASI / MOUNTING SCREW	BEFESTIGUNGSSCHRAUBE
2514-M16X35	M16X2.0	23.7	14	16	35	A32 MONTAJ VİDASI / MOUNTING SCREW	BEFESTIGUNGSSCHRAUBE
AAV-11-U5-40x4.5	UNC 5-40	5.4	T10	2.8	4.5	16 ER/L, 16 IR/L ALTLIK VİDASI / SHIM SCREW	SCHRAUBE FÜR UNTERLAGE
AAV-12-U8-32x5.5	UNC 8-32	6.7	T20	3.8	5.5	22 ER/L, 22 IR/L ALTLIK VİDASI / SHIM SCREW	SCHRAUBE FÜR UNTERLAGE
AAV-15-M5x5.7	M5X0.8	8.5	T20	3.15	5.7	27 ER/L, 27 IR/L ALTLIK VİDASI / SHIM SCREW	SCHRAUBE FÜR UNTERLAGE

Ürün Resmi
Product Picture
Produkt-Bild

SEKMAN / RING / RING

	Ürün Kodu Product Code / Code	Ürün Detayı / Product Detail / Produkt-Details	
	ACS-01	C-SİSTEM için / For C-SYSTEM / FÜR C-SYSTEM	TNGN, CNGN, DNGN, SNGN SEKMANI / RING
	AS-01	T-M-SİSTEM için / For T-M-SYSTEM / FÜR T-M-SYSTEM	AKV-30-M6x20 SEKMANI / RING

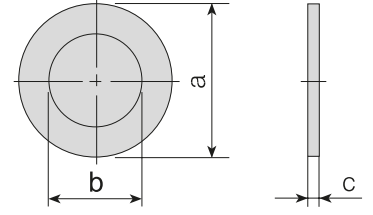

Takım Kodu Ordering Code Bestell-Bezeichnung	BASKI PULU / STAMP / UNTERLEGSCHIEBE			Ürün Detayı / Product Detail / Produkt-Details	
	a	b	c		
ABPL-01	11	6.5	0.5	PUL/STAMP/RING	BASKI PULU / -
ABPL-02	12.75	7.1	0.45	PUL/STAMP/RING	BASKI PULU / -

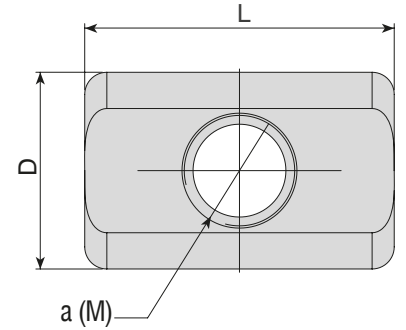
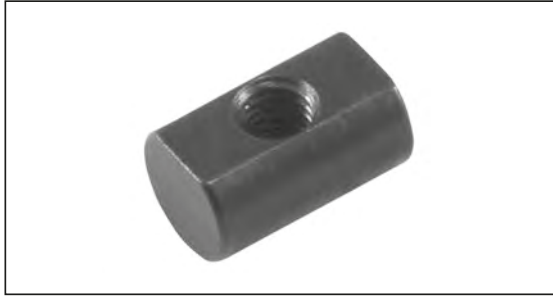

Takım Kodu Ordering Code Bestell-Bezeichnung	BARA PABUÇLARI / BORING HEADS CARTRIDGE / KASSETTE FÜR SPINDELKOPF			Ürün Detayı / Product Detail / Produkt-Details	
	a (M)	D	L		
ABKS-D16	M3x0.5	4.9	6	KABA BARA için / for ROUGH BORING HEADS / FÜR SCHRUPP-SPINDELKOPF	ABHR-D16x42-W16-L90
ABKS-D20	M4x0.7	5.9	9	KABA BARA için / for ROUGH BORING HEADS / FÜR SCHRUPP-SPINDELKOPF	ABHR-D20x50-W20-L100
ABKS-D25	M4x0.7	5.9	12	KABA BARA için / for ROUGH BORING HEADS / FÜR SCHRUPP-SPINDELKOPF	ABHR-D25x60-W20-L110
ABKS-D32	M5x0.8	8.9	14	KABA BARA için / for ROUGH BORING HEADS / FÜR SCHRUPP-SPINDELKOPF	ABHR-D32x64-W25-L120
ABKS-D40	M6x1	10.9	18	KABA BARA için / for ROUGH BORING HEADS / FÜR SCHRUPP-SPINDELKOPF	ABHR-D40x80-W32-L140
ABKS-D50	M8x1.25	13.9	28	KABA BARA için / for ROUGH BORING HEADS / FÜR SCHRUPP-SPINDELKOPF	ABHR-D50x100-W32-L160
ABKS-D63	M10x1.5	15.9	35	KABA BARA için / for ROUGH BORING HEADS / FÜR SCHRUPP-SPINDELKOPF	ABHR-D63x80-W32-L140, ABHR-D63x130-W40-L200
ABKS-D80	M12x1.75	17.9	45	KABA BARA için / for ROUGH BORING HEADS / FÜR SCHRUPP-SPINDELKOPF	ABHR-D80x140-W40-L210, ABHR-D80x140-W40-L210 - B



Ürün Resmi Product Picture Produkt-Bild	KESME ve KANAL LAMA AÇMA BLOK PABUÇLARI / BLOCKS FOR PARTING AND DEEP GROOVING BLADES CLAMPS KLEMMLEISTE FÜR SCHWERT-SPANNBLOCK		
	Ürün Kodu Product Code / Code	Ürün Detayı / Product Detail / Produkt-Details	
	ABK-01	LAMA BLOĞU için / For BLADE BLOCK / FÜR SCHWERT-SPANNBLOCK	ALBU-20-26 BASKI PABUCU / CLAMP / PRATZE
	ABK-02	LAMA BLOĞU için / For BLADE BLOCK / FÜR SCHWERT-SPANNBLOCK	ALBU-25-26 BASKI PABUCU / CLAMP / PRATZE
	ABK-03	LAMA BLOĞU için / For BLADE BLOCK / FÜR SCHWERT-SPANNBLOCK	ALBU-20-32 BASKI PABUCU / CLAMP / PRATZE
	ABK-04	LAMA BLOĞU için / For BLADE BLOCK / FÜR SCHWERT-SPANNBLOCK	ALBU-25-32, ALBU-32-32 BASKI PABUCU / CLAMP / PRATZE

Ürün Resmi Product Picture Produkt-Bild	LAMA ANAHTARI / BLADE KEY / SCHWERT-SCHLÜSSEL	
	Ürün Kodu Product Code / Code	Ürün Detayı / Product Detail / Produkt-Details
	ALA-01	AKL LAMA ANAHTARI / for BLADE KEY / SCHWERT-SCHLÜSSEL

Ürün Resmi Product Picture Produkt-Bild	ALYAN ANAHTARLARI / ALLEN KEYS / INNENSECHSKANT-SCHLÜSSEL		
	Ürün Kodu Product Code / Code	Ürün Detayı / Product Detail / Produkt-Details	
	AAL-01-2	2 mm	ALYAN ANAHTARI / ALLEN KEYS / INNENSECHSKANT-SCHLÜSSEL
	AAL-02-2.5	2.5 mm	ALYAN ANAHTARI / ALLEN KEYS / INNENSECHSKANT-SCHLÜSSEL
	AAL-03-3	3 mm	ALYAN ANAHTARI / ALLEN KEYS / INNENSECHSKANT-SCHLÜSSEL
	AAL-05-4	4 mm	ALYAN ANAHTARI / ALLEN KEYS / INNENSECHSKANT-SCHLÜSSEL
	AAL-07-5	5 mm	ALYAN ANAHTARI / ALLEN KEYS / INNENSECHSKANT-SCHLÜSSEL
	AAL-08-6	6 mm	ALYAN ANAHTARI / ALLEN KEYS / INNENSECHSKANT-SCHLÜSSEL
	AAL-09-1.5	1.5 mm	ALYAN ANAHTARI / ALLEN KEYS / INNENSECHSKANT-SCHLÜSSEL
	AAL-11-8	8 mm	ALYAN ANAHTARI / ALLEN KEYS / INNENSECHSKANT-SCHLÜSSEL
AAL-12-10	10 mm	ALYAN ANAHTARI / ALLEN KEYS / INNENSECHSKANT-SCHLÜSSEL	

Ürün Resmi Product Picture Produkt-Bild	TORK ANAHTARLARI / TORX KEYS / TORX-SCHLÜSSEL	
	Ürün Kodu Product Code / Code	Ürün Detayı / Product Detail / Produkt-Details
	80-T06	T06 TORK ANAHTARI / TORX KEY / TORX-SCHLÜSSEL
	80-T07	T07 TORK ANAHTARI / TORX KEY / TORX-SCHLÜSSEL
	80-T08	T08 TORK ANAHTARI / TORX KEY / TORX-SCHLÜSSEL
	80-T10	T10 TORK ANAHTARI / TORX KEY / TORX-SCHLÜSSEL
	80-T15	T15 TORK ANAHTARI / TORX KEY / TORX-SCHLÜSSEL
	80-T20	T20 TORK ANAHTARI / TORX KEY / TORX-SCHLÜSSEL
	81-T15	T15 T-TİP TORK ANAHTARI / T-TYPE TORX KEY / T-TYP-TORX-SCHLÜSSEL
	81-T20	T20 T-TİP TORK ANAHTARI / T-TYPE TORX KEY / T-TYP-TORX-SCHLÜSSEL